

GDB 2LS 层门 (地坎宽度=90MM)
Landing Doors Series GDB 2LS (Sill Width=90MM)

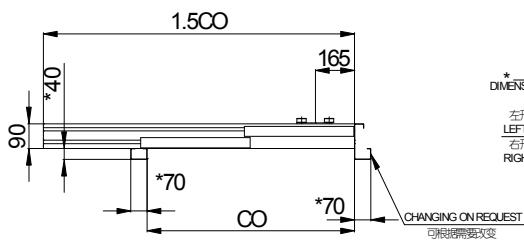

* 尺寸可根据需要改变
DIMENSIONS ARE CHANGEABLE ON REQUEST
左开门 | 如图标示
LEFT HAND | AS DRAWN
右开门 | 对称制作
RIGHT HAND | SYMMETRICALLY OPPOSITE

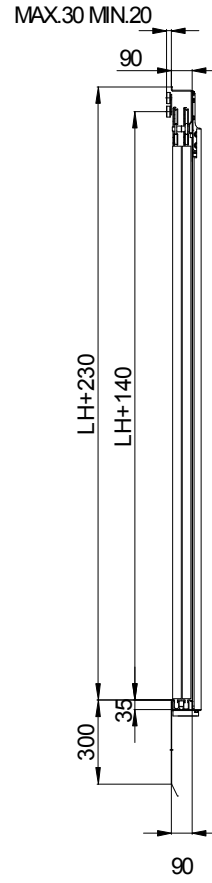
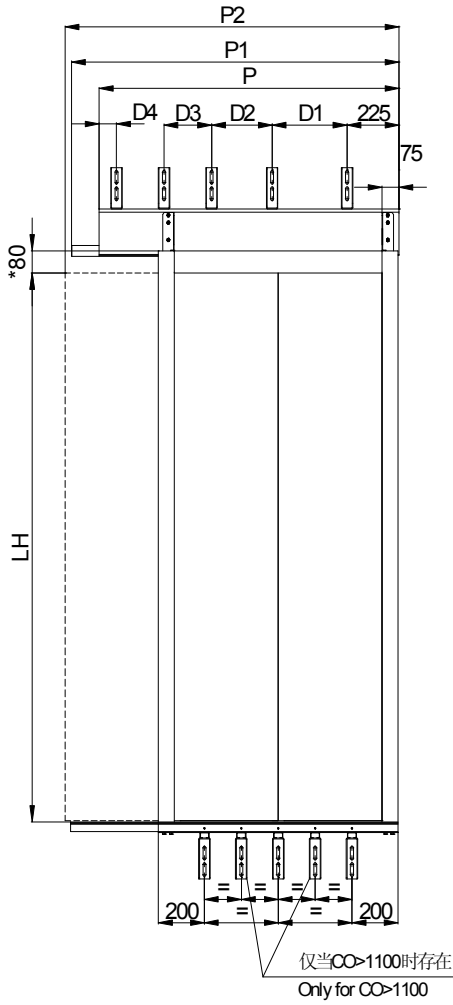
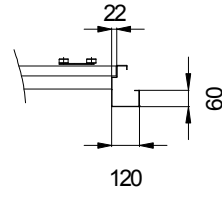

越层
RUNBY

CO	500	550	600	650	700	750	800	850	900	950	1000	1050	1100	1150	1200	1250	1300	1350	1400	1450	1500	1550	1600	1650	1700	1750	1800
P	840	840	1000	1000	1000	1000	1000	1000	1450	1450	1450	1450	1450	1450	1900	1950	2020	2120	2170	2320	2370	2470	2520	2620	2670	2770	2820
P1	875	935	1000	1050	1135	1235	1285	1335	1450	1500	1595	1645	1720	1820	1900	1950	2020	2120	2170	2320	2370	2470	2520	2620	2670	2770	2820
P2	850	925	1000	1075	1150	1225	1300	1375	1450	1525	1600	1675	1750	1825	1900	1975	2050	2125	2200	2275	2350	2425	2500	2575	2650	2725	2800
D1	250	275	300	325	350	375	400	425	450	475	500	525	550	575	600	625	650	675	700	550	550	550	550	550	550	550	600
D2	250	275	300	325	350	375	400	425	450	475	500	525	550	575	600	625	650	675	700	550	550	550	550	550	550	550	600
D3	/	/	/	/	/	/	/	/	/	/	/	/	/	/	/	/	/	/	/	450	450	450	600	600	600	600	600
D4	/	/	/	/	/	/	/	/	/	/	/	/	225	225	225	225	225	225	225	225	225	225	225	225	225	225	225

GDB 2LS 层门 (地坎宽度=90MM)
Landing Doors Series GDB 2LS (Sill Width=90MM)

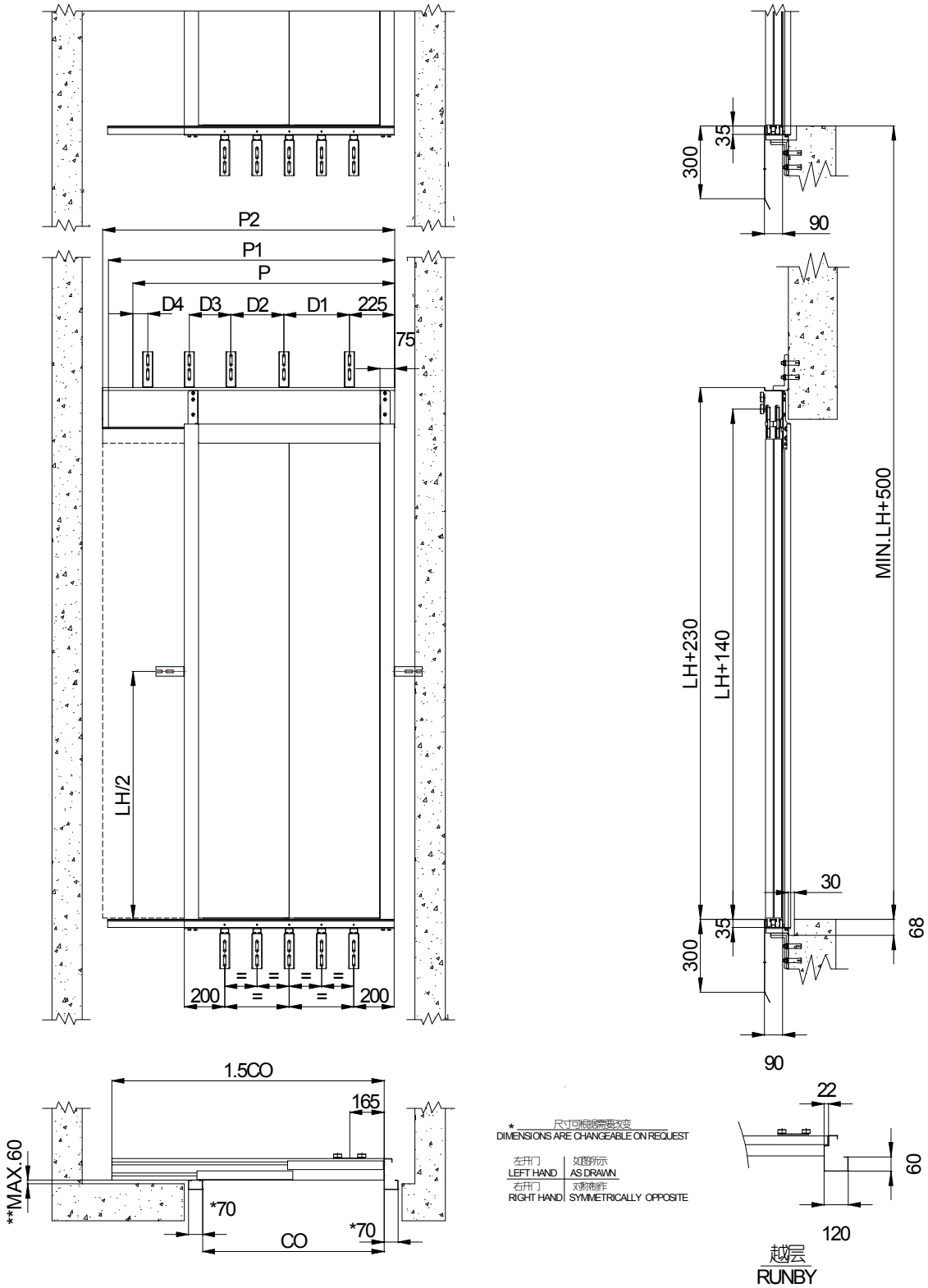

** 可通过更换支架调节到更大尺寸
DIMENSIONS ARE CHANGEABLE BY CHANGE BRACKET

GDB 3LS 层门 (地坎宽度=136MM)
Landing Doors Series GDB 3LS (Sill Width=136MM)

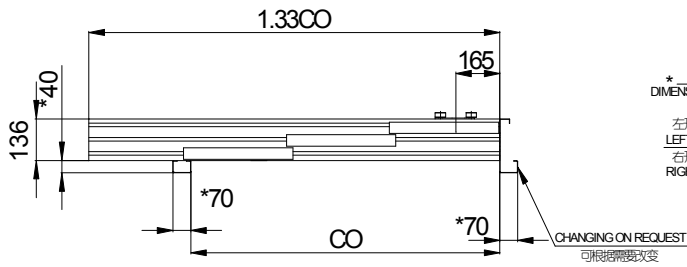
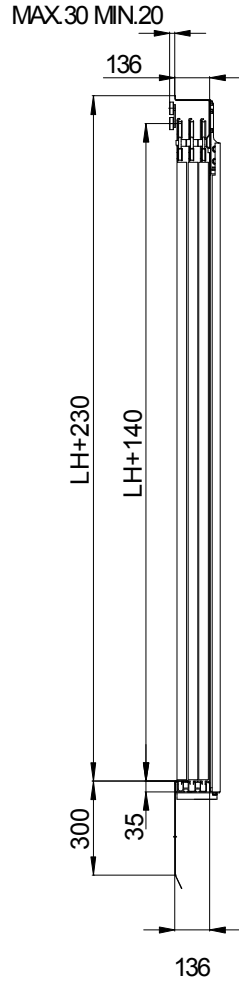
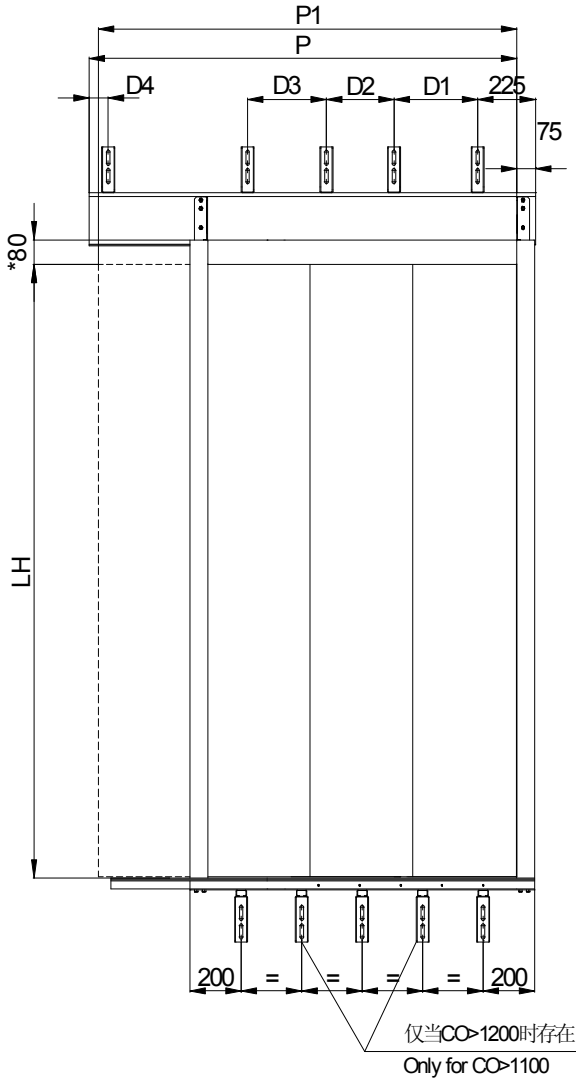

* 尺寸可根据需要改变
DIMENSIONS ARE CHANGEABLE ON REQUEST

左开门	如图所示
LEFT HAND	AS DRAWN
右开门	对称制作
RIGHT HAND	SYMMETRICALLY OPPOSITE

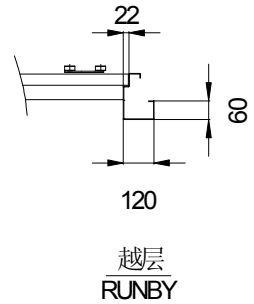

CO	600	650	700	750	800	850	900	950	1000	1050	1100	1150	1200	1250	1300	1350	1400	1450	1500	1550	1600	1650	1700	1750	1800	1850	1900	1950	2000	2050	2100
P	950	1000	1050	1100	1150	1200	1275	1325	1375	1460	1510	1610	1660	1710	1825	1875	1925	1975	2070	2120	2195	2245	2345	2395	2475	2525	2575	2645	2745	2795	2845
P1	825	892	958	1025	1092	1158	1225	1292	1358	1425	1492	1558	1625	1692	1758	1825	1892	1958	2025	2092	2158	2225	2292	2358	2425	2492	2558	2625	2692	2758	2825
D1	225	250	275	300	325	350	375	400	425	450	475	500	350	350	400	400	400	410	435	445	465	475	505	515	530	550	560	580	605	615	630
D2	225	250	275	300	325	350	375	400	425	450	475	500	350	350	400	400	400	410	435	445	465	475	505	515	530	550	560	580	605	615	630
D3	/	/	/	/	/	/	/	/	/	/	/	/	350	350	400	400	400	410	435	445	465	475	505	515	530	550	560	580	605	615	630
D4	/	/	/	/	/	/	/	/	/	100	100	100	100	100	100	100	100	100	100	100	100	100	100	100	100	100	100	100	100	100	100

GDB 3LS 层门 (地坎宽度=136MM)
Landing Doors Series GDB 3LS (Sill Width=136MM)

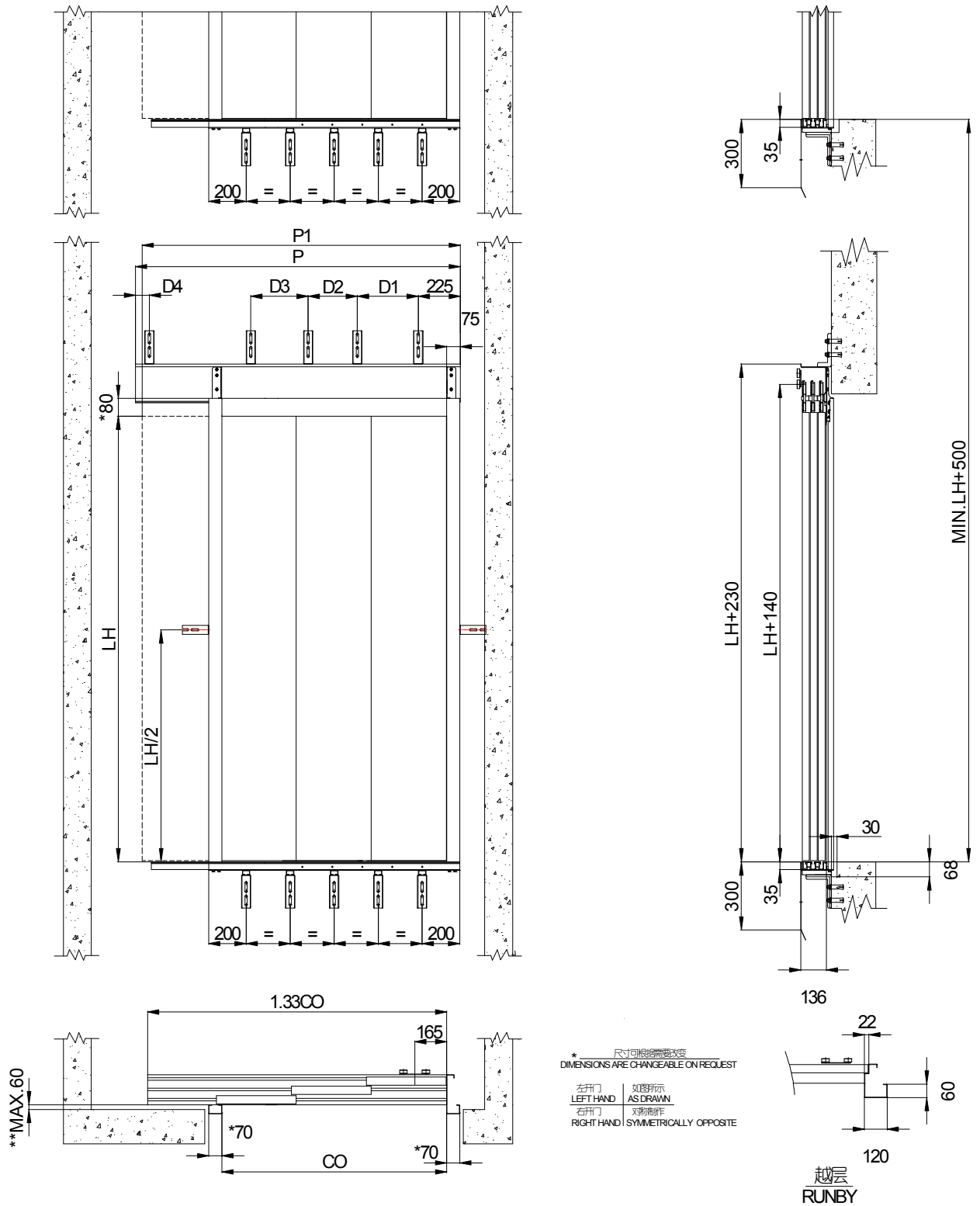

GDB2LS E120 防火层门 符合 EN81:58

Fire Test Landing Doors Series GDB2LS E120 According To EN81:58

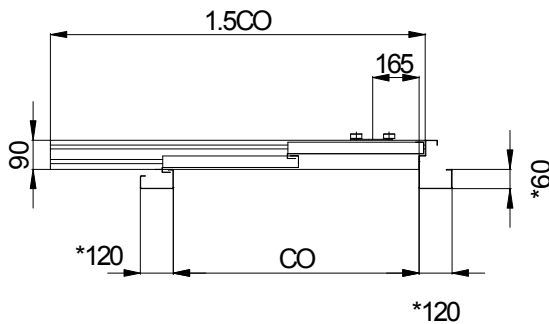
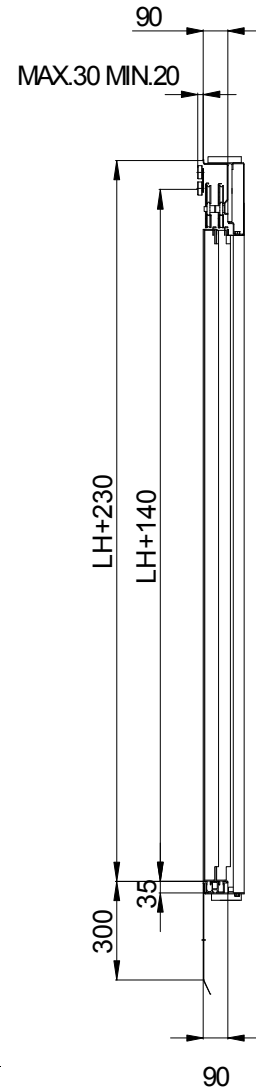
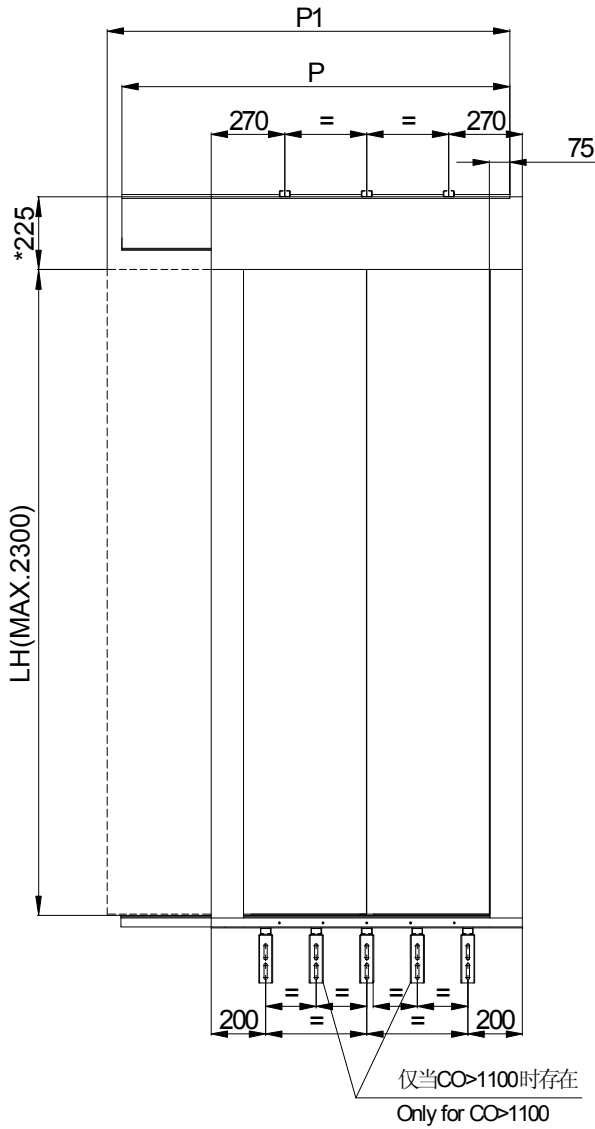

* 尺寸可根据需要改变
DIMENSIONS ARE CHANGEABLE ON REQUEST

左开门 LEFT HAND	如图所示 AS DRAWN
右开门 RIGHT HAND	对称制作 SYMMETRICALLY OPPOSITE

CO	700	750	800	850	900	950	1000	1050	1100	1150	1200	1250	1300
P	1135	1235	1285	1710	1890	1940	2080	2130	2230	2380	2490	2540	2630
P1	1150	1225	1300	1400	1475	1550	1625	1700	1775	1850	1925	2000	2075

GDB 2LS E120 防火层门井道符合 EN81:58

Shaft Wall In Fire Test Landing Doors Series GDB 2LS E120 According To EN81:58

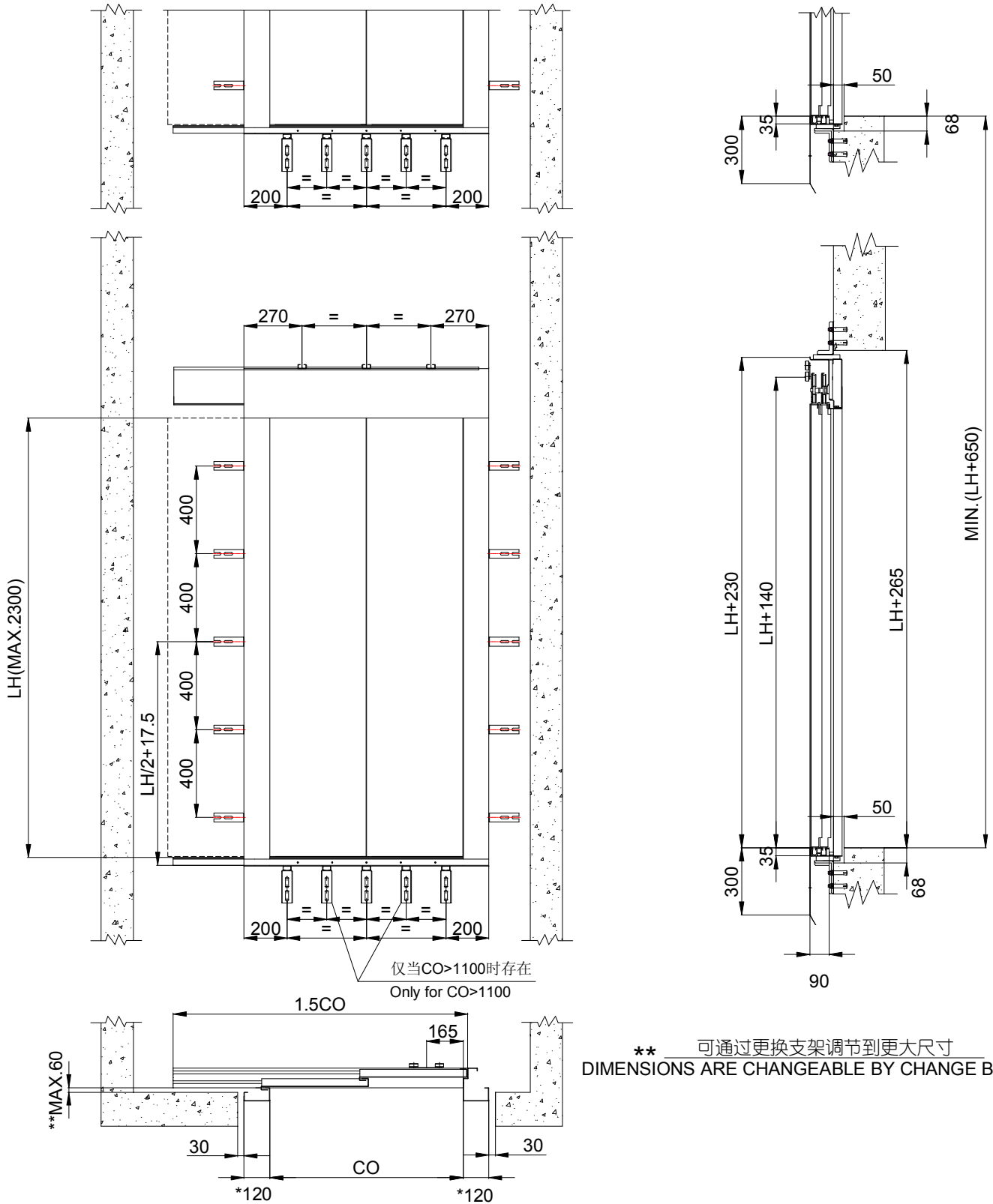

GDB 2LC E120 防火层门井道符合 EN81:58

Shaft Wall In Fire Test Landing Doors Series GDB 2LC E120 According To EN81:58

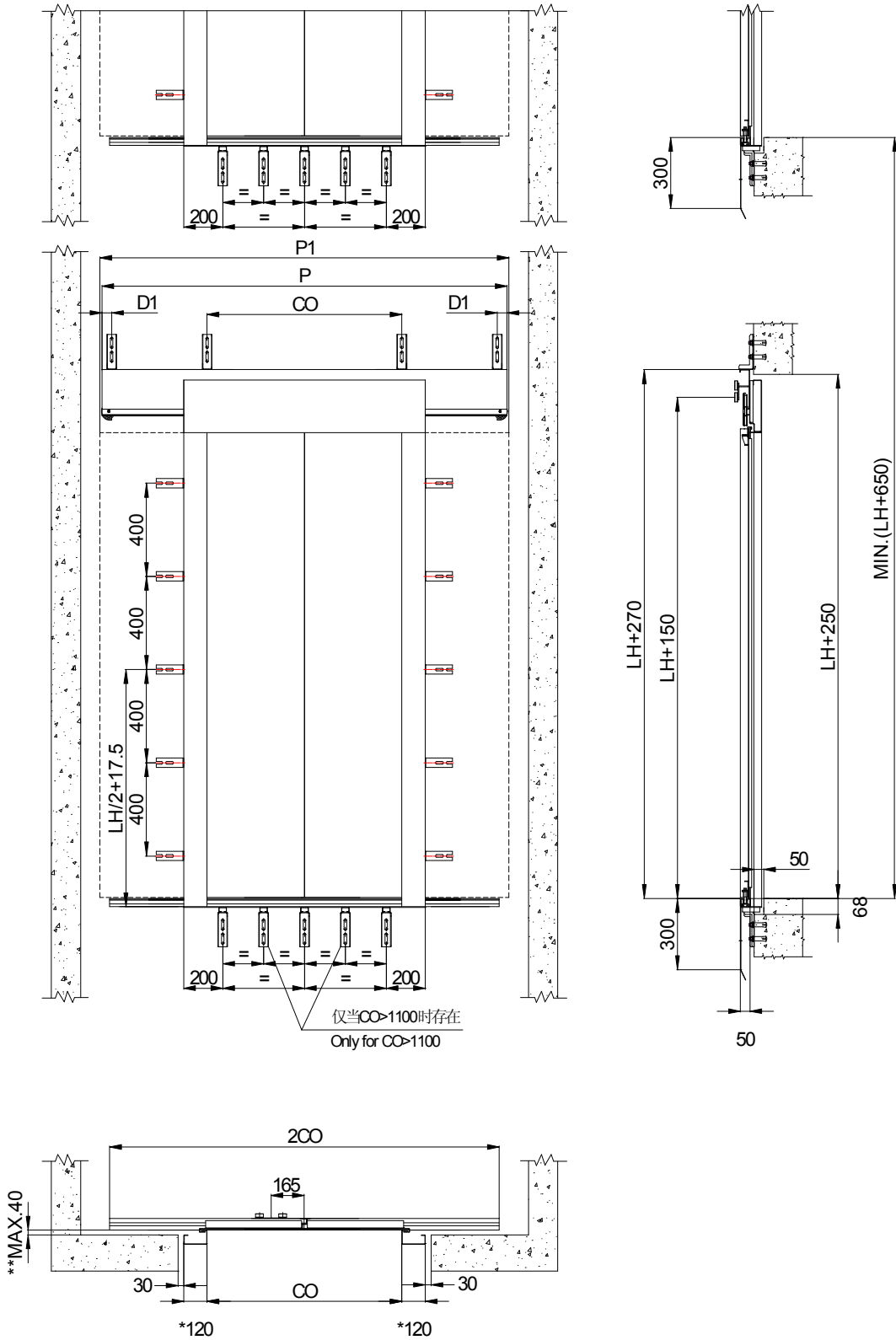

** 可通过更换支架调节到更大尺寸
DIMENSIONS ARE CHANGEABLE BY CHANGE BRACKET